



# SISTEMELE DE RIGOLE KENADRAIN SI CONNECTO



# Gama KENADRAIN

Conforme cu standardul EN 1433  
(C E - Declaratie de conformitate)



# Gama KENADRAIN HD (trafic greu)



Material : Polipropilena – Canal tip M cu muchii ranforsate metalic din otel galvanizat – grosime de 4 mm pentru clasa D400/2mm pentru celelalte clase.  
Rigolele cu grilaje fixate sunt livrate la nivel paletat.

## Rigola latime 100

Lungime rigola 1m.  
Lungime grilaj: 1 m cu exceptia grilajelor de fonta: 0,50 m.  
Livrare la palet de 40 m.  
Iesiri verticale: 100, 110, 125 – iesiri laterale: 100, 110.

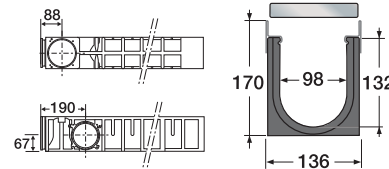

Kenadrain HD



Cod produs	Cod palet	Tip grilaj	Clasa de rezistenta	Dimensiunea fantei mm	Greutate kg/m	Suprafata sectiunii interioare (cm <sup>2</sup> /m)	
DR102AP	PR102AP	Otel galvanizat cu fante	A15	10/80	7,9	260	
DR102BC	PR102BC	Otel galvanizat tip sita	B125	15/30	9,0	830	
DR102CF	PR102CF	Fonta	C250	10/95	12,7	490	
DR102CC	PR102CC	Otel galvanizat tip sita	C250	15/30	9,6	830	
DR102DF	PR102DF	Fonta	D400	10/95	16,3	490	

In curand va aparea si o gama de grilaje din otel inoxidabil.

## Rigola latime 100 cu sistemul de prindere fara suruburi "Eclipse"



DE102CF	PE102CF	Fonta	C250	10/95	14,0	490	
DE102DF	PE102DF	Fonta	D400	10/95	16,8	490	

## Rigola latime 100 cu profil special pentru tocuri



DR102CH	PR102CH	Fonta neagra cu profil special pentru tocuri	C250	6/95	13,5	300	
---------	---------	--	------	------	------	-----	--

\*\* La cerere se pot pune la dispozitie grile de fonta vopsite cu profil special pentru tocuri.



Coduri RAL orientative

DR102CH8015	DR102CH1015	DR102CH5008	DR102CH7046	DR102CH6028	
-------------	-------------	-------------	-------------	-------------	--

# Gama KENADRAIN HD (trafic greu)



## Rigola latime 150

Lungime rigola 1m.

Lungime grilaj: 1 m cu exceptia grilajelor de fonta: 0,50 m.

Livrare la palet de 30m

Iesiri verticale: 160 – iesiri laterale: 100, 110 si 125.

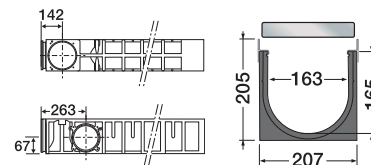

EN1433  
CE



EN1433  
CE

Cod produs	Cod palet	Tip grilaj	Clasa de rezistenta	Dimensiunea fantei mm	Greutate kg/m	Suprafata sectiunii interioare (cm <sup>2</sup> /m)	
DR152BC	PR152BC	Otel galvanizat tip sita	B125	15/30	14,0	1230	
DR152CF	PR152CF	Fonta	C250	2 randuri 10/80	21,0	752	
DR152DF	PR152DF	Fonta	D400	2 randuri 10/80	25,0	752	

## Rigola latime 200

Lungime 1m

Lungime grilaj: 1m cu exceptia grilajelor de fonta: 0,50m

Livrare la palet de 20 m.

Iesiri verticale: 200 – iesiri laterale: 160

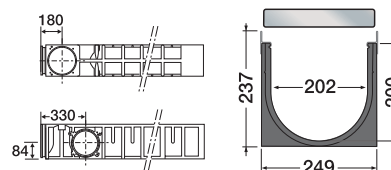

EN1433  
CE



EN1433  
CE

Cod produs	Cod palet	Tip grilaj	Clasa de rezistenta	Dimensiunea fantei mm	Greutate kg/m	Suprafata sectiunii interioare (cm <sup>2</sup> /m)	
DR202BC	PR202BC	Otel galvanizat tip sita	B125	15/30	19,7	1530	
DR202CF	PR202CF	Fonta	C250	2 randuri 10/100	25,9	1010	
DR202DF	PR202DF	Fonta	D400	2 randuri 10/100	31,3	1010	

Alte tipuri de grilaj: va rugam sa ne contactati.

## Rigola latime 300

Lungime 1m

Lungime grilaj: 1m cu exceptia grilajelor de fonta: 0,50m

Livrare la palet de 9m

Iesiri verticale: 315 – iesiri laterale: 200

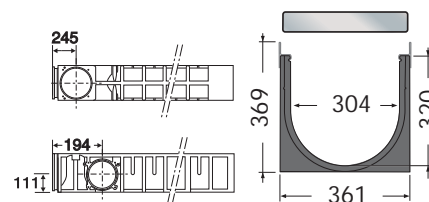

EN1433  
CE

Cod produs	Cod palet	Tip grilaj	Clasa de rezistenta	Dimensiunea fantei mm	Greutate kg/m	Suprafata sectiunii interioare (cm <sup>2</sup> /m)	
DR302CF	PR302CF	Fonta	C250	3 randuri 10/100	49,0	1410	
DR302DF	PR302DF	Fonta	D400	3 randuri 10/100	59,3	1410	

# Gama KENADRAIN MD (trafic mediu)



Material : Polipropilena – Canal tip M fara muchii ranforsate metalic.  
Rigolele cu grilaje fixate sunt livrate la nivel paletat.

## Canal latime 100

Lungime 1m  
Lungime grilaj: 1m cu exceptia grilajelor de fonta: 0,50m  
Livrare la palet de 40m  
Iesiri verticale: 100, 110, 125 – Iesiri laterale: 100, 110.

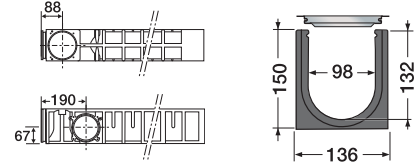

Cod produs	Cod palet	Tip grilaj	Clasa de rezistenta	Dimensiunea fantei mm	Greutate kg/m	Suprafata sectiunii interioare (cm <sup>2</sup> /m)
DL102BC	PL102BC	Otel galvanizat tip sita	B125	15/30	8,5	730
DL102CF	PL102CF	Fonta	C250	10/90	10,6	404

## Rigola latime 150

Lungime 1m  
Lungime grilaj: 1m cu exceptia grilajelor de fonta: 0,50m  
Livrare la palet de 30m  
Iesiri verticale: 160 – Iesiri laterale: 100, 110, 125

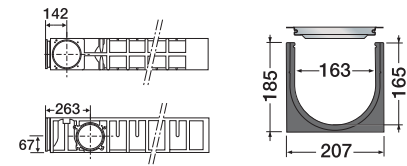

Cod produs	Cod palet	Tip grilaj	Clasa de rezistenta	Dimensiunea fantei mm	Greutate kg/m	Suprafata sectiunii interioare (cm <sup>2</sup> /m)
DL152BC	PL152BC	Otel galvanizat tip sita	B125	15/30	13,0	1218
DL152CF	PL152CF	Fonta	C250	2 randuri 10/70	19,9	704

## Rigola latime 200

Lungime 1m  
Lungime grilaj: 1m cu exceptia grilajelor de fonta: 0,50m  
Livrare la palet de 20m  
Iesiri verticale: 200 – Iesiri laterale: 160

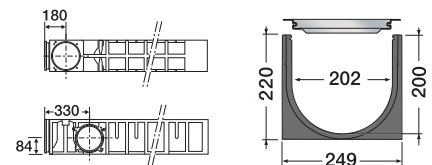

Cod produs	Cod palet	Tip grilaj	Clasa de rezistenta	Dimensiunea fantei mm	Greutate kg/m	Suprafata sectiunii interioare (cm <sup>2</sup> /m)
DL202BC	PL202BC	Otel galvanizat tip sita	B125	15/30	15,7	1430
DL202CF	PL202CF	Fonta	C250	2 randuri 10/90	24,2	930

# Gama KENADRAIN HD/MD



## Accesorii

### Capace cu intrari-iesiri PVC



Latime rigola	Ø iesire (mm)	Cod produs HD	Cod produs MD
100	100	NTDR102	NTDL102
	110	NVDR102	NVDL102
150	125	NXDR152	NXDL152
200	160	NZDR202	NZDL202
300	250	NDDR302	

### Iesiri verticale-laterale PVC



Latime rigola	Ø iesire (mm)	Cod produs HD/MD	Tip
100	100	STDR10	verticala/laterala
	110	SVDR10	verticala/laterala
100/150	125	SXDR10	verticala/laterala
150/200	160	SZDR20	verticala/laterala
200/300	200	SBDR20	verticala/laterala
300	315	SEDR30	verticala

## Decantoare

### Ekso

Latime rigola	Ø iesire Ds	Cod produs iesirea inferioara	Cod produs iesirea superioara	Ø (mm)		Inaltime (mm) H.Min/Max	Inaltime (mm) iesire inferioara h2	Inaltime (mm) iesire superioara h2
				D1	D2			
100	110	PS100V	PS100VH	140	90	590/620	140	400
100	125	PS100X	PS100XH	140	90	590/620	140	400
150	160	PS150Z	PS150ZH	200	140	590/620	175	390
200	200	PS200B	PS200BH	200	160	590/620	185	360
300	315	PS300E		400	250	590/620	230	

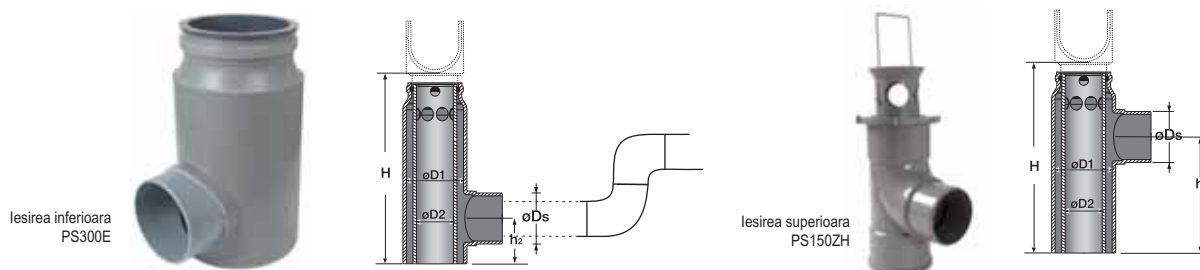

Gama Ekso poate fi folosita si la rigolele din gama CONNECTO.

### Kit suruburi antivandalism din otel inoxidabil pentru rigolele Kenadrain 150, 200 si 300

	Cod produs
Set de 24 de suruburi	VISDRI
Cheie pentru suruburi	CLEDRI



# Gama KENADRAIN HD in cascada



Material: Polipropilena – Rigole tip M cu ranforsate metalic din otel galvanizat – grosime de 4 mm pentru clasa D400/2mm pentru celelalte clase.

## Rigola latime 100

Lungime 1m

Lungime grilaje: 1m cu exceptia grilajelor de fonta: 0,50m

Livrare la palet de 40m pentru adancimile 1-2, de 35m pentru 3, de 28m pentru 4.

Iesiri verticale: 100, 110, 125 – iesiri laterale: 100, 110, 160



Kenadrain HD

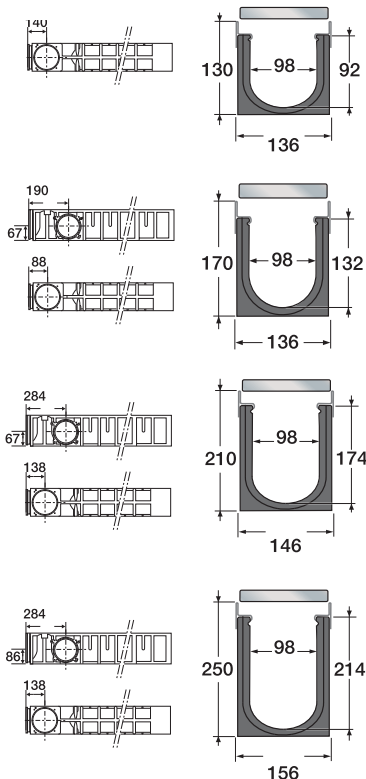

Adancime	Cod produs	Cod palet	Tip grilaj	Clasa de rezistenta	Dimensiunea fantei (mm)	Greutate kg/m	Suprafata sectiunii interioare cm <sup>2</sup> /m
1	DR101BC	PR101BC Pallet 40 m	Otel galvanizat tip sita	B125	15/30	8,0	830
	DR101CF	PR101CF Pallet 40 m	Fonta	C250	10/95	11,7	490
	DR101DF	PR101DF Pallet 40 m	Fonta	D400	10/95	16,0	490
2	DR102BC	PR102BC Pallet 40 m	Otel galvanizat tip sita	B125	15/30	9,0	830
	DR102CF	PR102CF Pallet 40 m	Fonta	C250	10/95	12,7	490
	DR102DF	PR102DF Pallet 40 m	Fonta	D400	10/95	16,3	490
3	DR103BC	PR103BC Pallet 35 m	Otel galvanizat tip sita	B125	15/30	10,1	830
	DR103CF	PR103CF Pallet 35 m	Fonta	C250	10/95	13,8	490
	DR103DF	PR103DF Pallet 35 m	Fonta	D400	10/95	17,4	490
4	DR104BC	PR104BC Pallet 28 m	Otel galvanizat tip sita	B125	15/30	11,0	830
	DR104CF	PR104CF Pallet 28 m	Fonta	C250	10/95	14,7	490
	DR104DF	PR104DF Pallet 28 m	Fonta	D400	10/95	18,3	490

Pentru alte tipuri de grilaje si pentru gama MD va rugam sa ne contactati.

Sistemul "Eclipse" este disponibil la grilajele de fonta. Fiecare treapta de adancime a sistemului KENADRAIN cascada poate fi folosita independent pentru a respecta diferite restrictii impuse pe santiere.

## Accesorii pentru sistemul cascada

### Capace cu intrari-iesiri PVC pentru latimea de 100 (gama HD)



Treapta adancime	Ø	Cod produs
1	75	NPDR101
2	100	NTDR102
	110	NVDR102
3	100	NTDR103
	110	NVDR103
4	100	NTDR104
	110	NVDR104

### Conector trepte adancime

Cod produs
SAB10



# Gama KENADRAIN PARK HD



Material : Polipropilena – Canal tip M  
 muchii ranforsate metalic din otel galvanizat  
 grosime de 4 mm pentru clasa D400/2mm pentru celelalte

## Rigola latime 100

Lungime 1m  
 Lungime grilaj: 1m cu exceptia grilajelor de fonta: 0,50m  
 Livrare la palet de 40 m.  
 Iesiri verticale: 100, 110, 125.

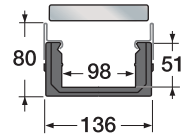
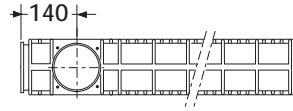

Cod produs	Cod palet	Tip grilaj	Clasa de rezistenta	Dimensiunea fantei mm	Greutate kg/m	Suprafata sectiunii interioare cm <sup>2</sup> /m	
DR100BC	PR100BC	Otel galvanizat tip sita	B125	15/30	6,7	830	
DE100CF	PE100CF	Fonta	C250	10/95	9,5	490	
DR100CF	PR100CF	Fonta	C250	10/95	10,3	490	
DR100CH	PR100CH	Fonta neagra cu profil special pentru tocuri	C250	6/95	11,3	300	
DE100DF	PE100DF	Fonta	D400	10/95	13,7	490	
DR100DF	PR100DF	Fonta	D400	10/95	14,7	490	

\* Alte tipuri de grilaje: va rugam sa ne contactati.

## Accesorii pentru gama Park HD



### Capace cu intrari-iesiri PVC

Ø intrare/iesire mm	Cod produs	
50	NJDR100	



Kenadrain Park

# CONNECTO

Sistem de rigole de jur imprejurul cladirii

Conform cu standardul EN 1433  
(C E - Declaratie de conformitate)



Connecto

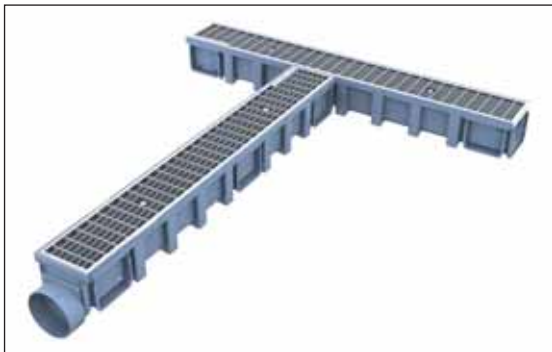
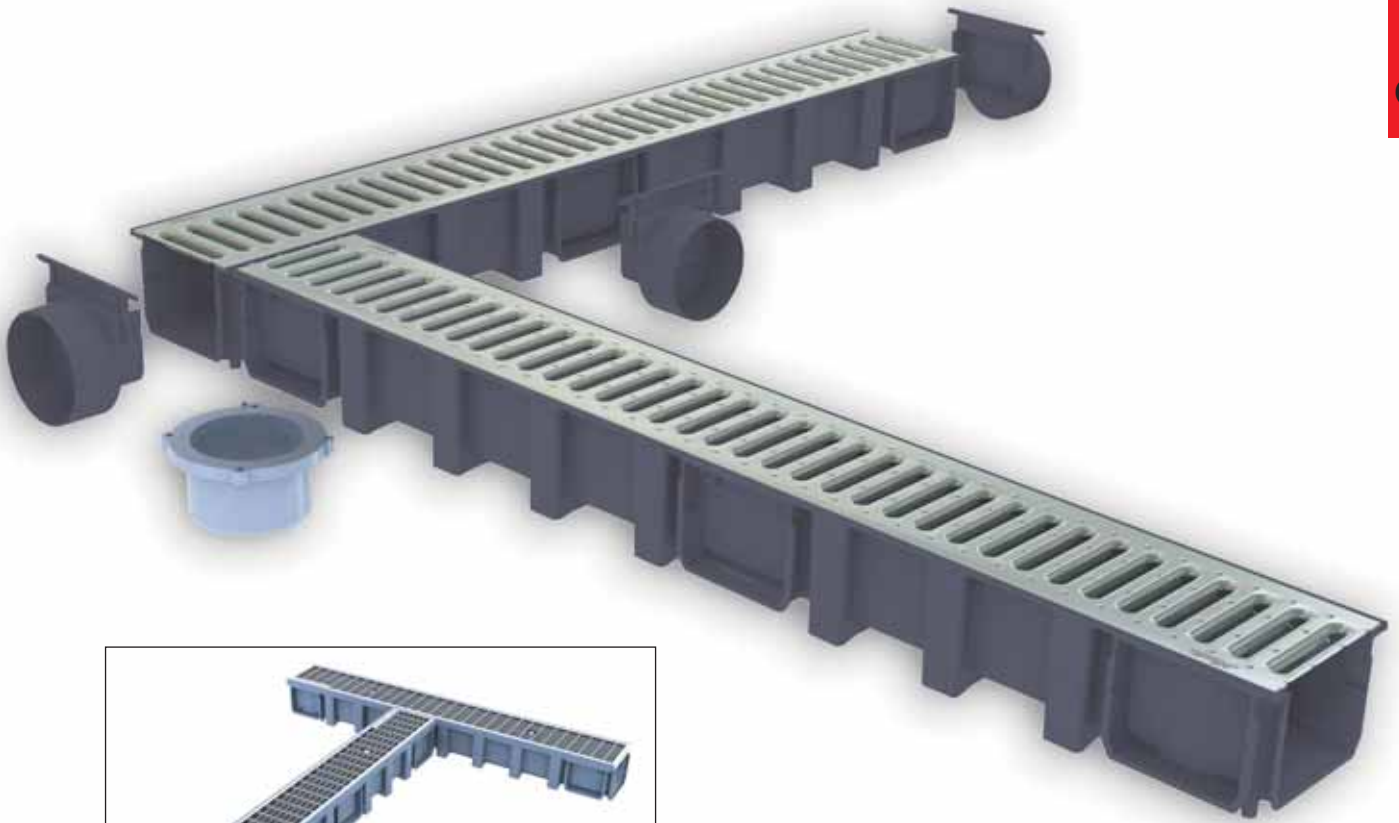

# Gama CONNECTO cu grilaj metalic



Materiale : Polipropilena/PVC – Canale tip M.  
Rigolele Connecto cu grilaje ansamblate se livreaza la palet.

## Rigola polipropilena latime 130 cu muchii neranforsate

Lungime 1m – din polipropilena  
Lungime grilaj: 1m cu exceptia grilajelor de fonta: 0,50m  
Livrare la palet de 56m, cu grilaje neinsurubate.  
Iesiri verticale: 100, 110 – Iesire laterala/de capat 100, 110.

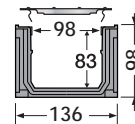

Cod Produs	Cod palet	Tip grilaj	Clasa de rezistenta	Dimensiunea fantei (mm)	Greutate kg/m	Suprafata sectiunii interioare cm <sup>2</sup> / m
DRP178	PDRP178	Otel galvanizat cu fante	A15	10/80	2,8	260
CAL10BF	PAL10BF	Fonta	B125	10/70	5,7	470

Pentru insurubarea grilajelor: va rugam sa folositi setul FIXCAN1.  
Pentru alte tipuri de grilaje sau alte clase de rezistenta va rugam sa ne contactati.  
In curand va aparea si o gama de grilaje din otel inoxidabil.

## Rigola polipropilena latime 130 cu muchii ranforsate

Lungime 1m - polipropilena  
Lungime grilaj: 1m cu exceptia grilajelor din fonta: 0,50m.  
Livrare la palet de 32 m, cu grilaje neinsurubate.  
Iesire verticala: 100, 110 – Iesire laterala/de capat 100, 110.

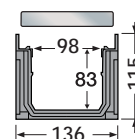

Cod Produs	Cod palet	Tip grilaj	Clasa de rezistenta	Dimensiunea fantei (mm)	Greutate kg/m	Suprafata sectiunii interioare cm <sup>2</sup> / m
CAN10BC	PAN10BC	Otel galvanizat tip sita	B125	15/30	3,9	830

## Rigola PVC de mica adancime latime 130 cu muchii ranforsate

Lungime 1m  
Lungime grilaj : 1m cu exceptia grilajelor de fonta: 0,50m.  
Livrare la palet de 32 m, cu grilaje neinsurubate.  
Iesire verticala : 100, 110 – Iesire laterala/de capat 40.

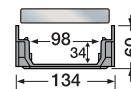

Cod Produs	Cod palet	Tip grilaj	Clasa de rezistenta	Dimensiunea fantei (mm)	Greutate kg/m	Suprafata sectiunii interioare cm <sup>2</sup> / m
CAB10BC	PAB10BC	Otel galvanizat tip sita	B125	15/30	3,9	830

Alte tipuri de grilaj: va rugam sa ne contactati.  
In curand va aparea si o gama de grile din otel inoxidabil.

# Rigola polipropilena latime 200 cu muchii ranforsate

Lungime 1m - polipropilena

Lungime grilaj : 1m cu exceptia grilajelor de fonta: 0,50m.

Rigolele cu grilaje ansamblate se livreaza la palet de 30m.

Iesiri verticale : 125 – iesiri laterale: 100, 110.

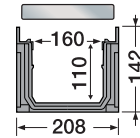

EN1433  
CE

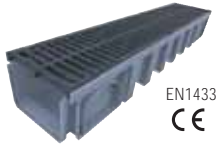

EN1433  
CE

Cod Produs	Cod palet	Tip grilaj	Clasa de rezistenta	Dimensiunea fantei (mm)	Greutate kg/m	Suprafata sectiunii interioare cm2/ m
CAN15BC	PAN15BC	Otel galvanizat tip sita insurbat	B125	15/30	8,3	1230
CAN15BF *	PAN15BF	Fonta	B125	2 randuri 10/80	11,4	870

\* Exista posibilitatea de a insuruba grilajele folosind setul FIXCAN2.

Pentru alte tipuri de grilaje sau alte clase de rezistenta va rugam sa ne contactati.

## Accesorii pentru gama CONNECTO

### Capace de inchidere/iesire laterala/capat din PVC

#### Latime 130



NAT177

NAH773

NAT178

Pentru	Ø iesire mm	Cod produs
CAN10BC	100	NAT177
	110	NAV177
CAB10BC	40	NAH773
	DRP178 / CAL10BF	100
110		NAV178

#### Latime 200



NAT188

Pentru	Ø iesire mm	Cod produs
CAN15BC / CAN15BF	100	NAT188
	110	NAV188
	125	NAX188

#### Iesiri verticale



STCAN

SXCAN

Ø iesire mm	Cod produs
100	STCAN
110	SVCAN
125	SXCAN

### Sisteme de insurubare pentru grilaje

Set de 10 suruburi din otel inoxidabil si 10 piulite din alama.

FIXCAN1 pentru rigolele de latime 130

FIXCAN2 pentru rigolele de latime 200



### Decantare pentru gama Connecto (latimi 130 si 200 mm).

Aceasta gama Ekso poate fi utilizata si la sistemele Kenadrain.



PPSCV

COPSCV

CRAP

Descriere	Cod produs
Decantor iesire 100 mm	COPSCVT
Decantor iesire 110 mm	COPSCVW
Recipient pentru decantor	PPSCV
Parafrunzar pentru rigola	CRAP

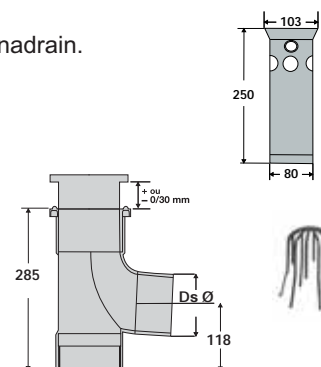



*an OAliaxis company*

**Head office and plants :**  
P.O. Box 10966 - Rue Pierre et Marie Curie  
**49309 CHOLET CEDEX FRANCE**  
Tel. 33 2 41 63 73 83 - Fax 33 2 41 63 73 57  
**Website :** [www.nicoll.fr](http://www.nicoll.fr) - [www.nicoll.com](http://www.nicoll.com).  
**e-mail :** [export.nicoll@aliaxis.com](mailto:export.nicoll@aliaxis.com)  
SAS au capital de 7 683 431 € - 060 200 128 RCS Angers



Document non contractuel

**2008**